

Camden Geological, Hydrogeological and Hydrological Study Watercourses

Source – Barton, Lost Rivers of London

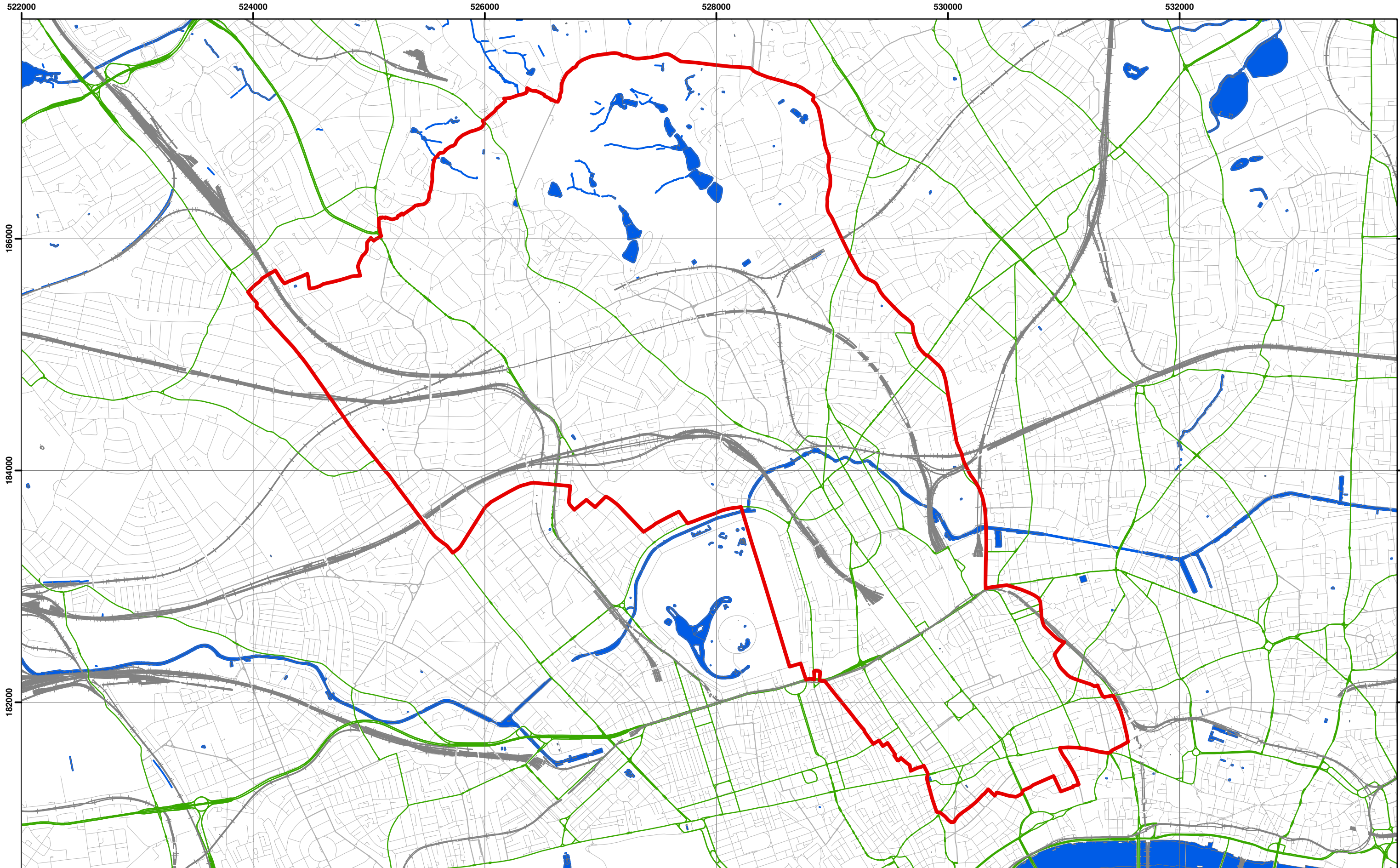

Data Source: London Borough of Camden, 2010



Scale at A3: 1:30,000

Coordinate System:
British National Grid
GCS_OSGB_1936

Legend

- London Borough of Camden
- Surface water
- Railway Lines
- A Roads

**Camden Geological, Hydrogeological
and Hydrological Study**

Camden Surface Water Features



213923

FIGURE

12

Welcome to Hampstead Heath

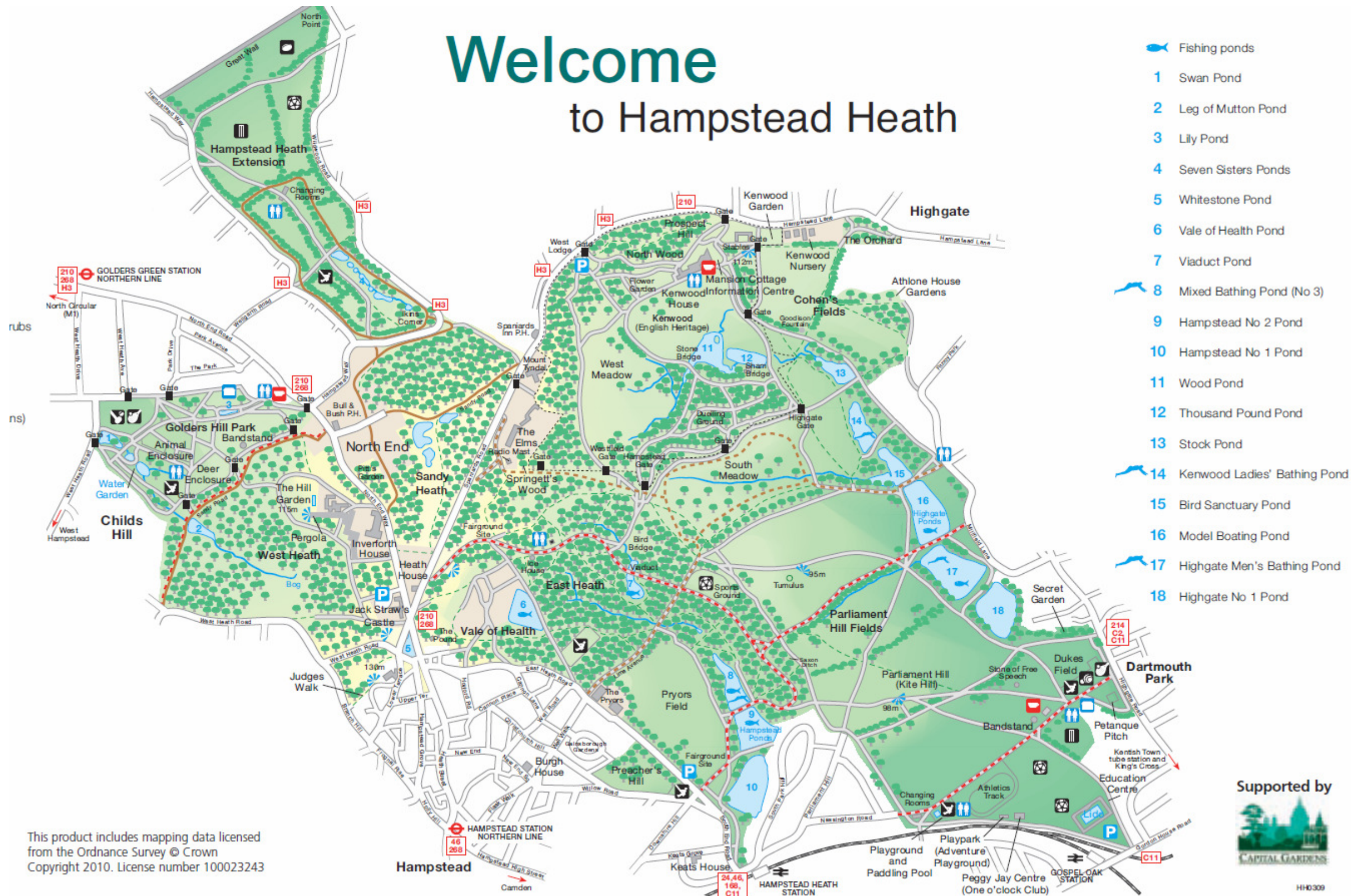

This product includes mapping data licensed from the Ordnance Survey © Crown Copyright 2010. License number 100023243



Source – City of London, 2010, Welcome to Hampstead Heath Leaflet

Camden Geological, Hydrogeological and Hydrological Study
Hampstead Heath Map

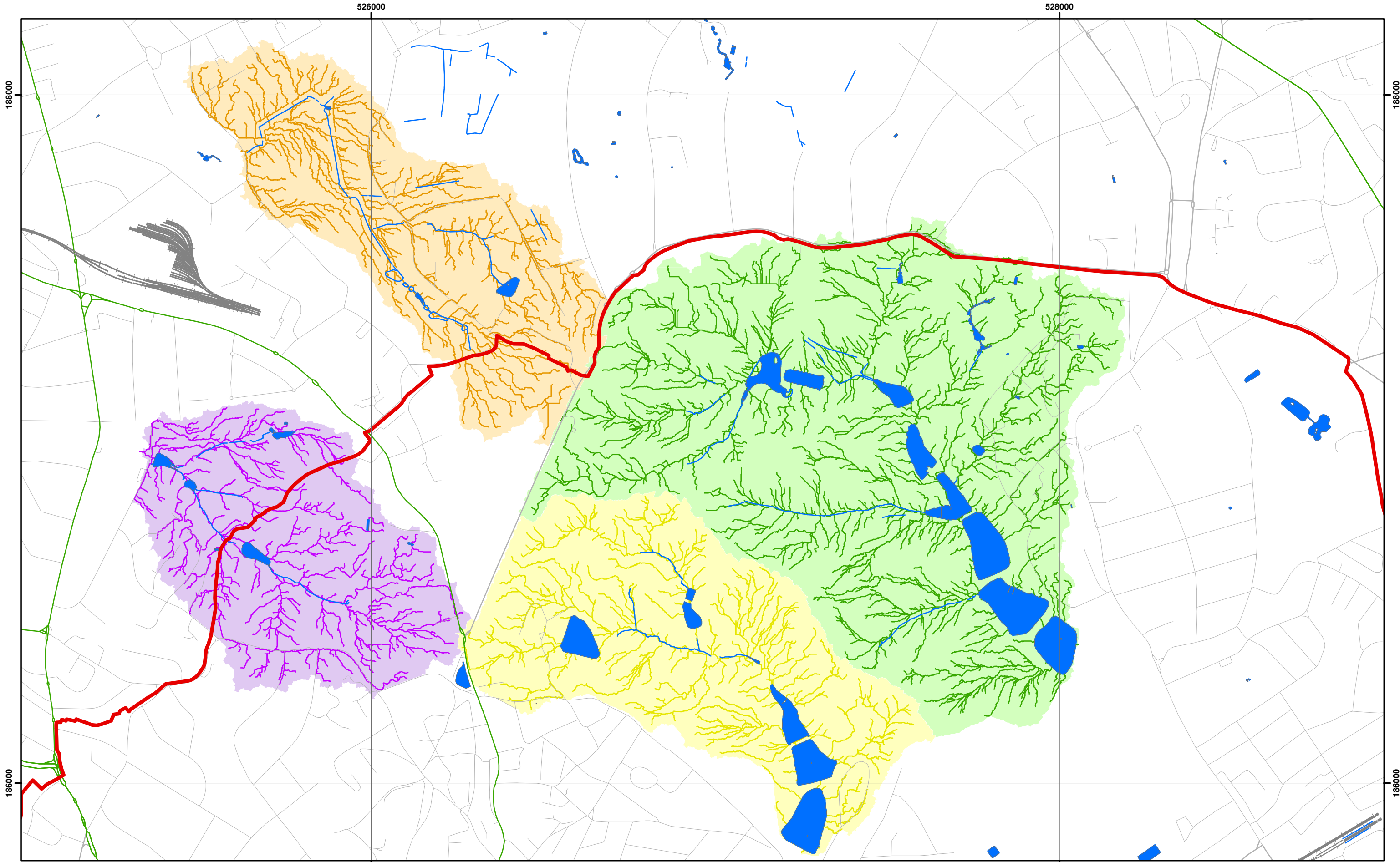

Catchments and Drainage after Haycock, 2010

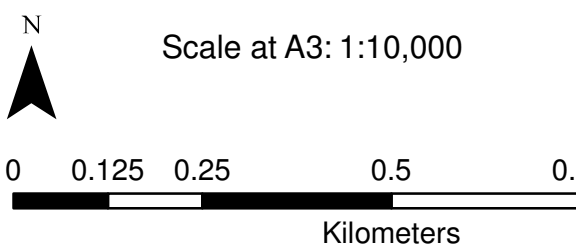

Coordinate System:
British National Grid
GCS_OSGB_1936

Legend

- London Borough of Camden
- Surface Water
- Railway Lines
- A Roads
- Highgate Chain Catchment
- Golders Hill Chain Catchment
- Hampstead Chain Catchment
- Hampstead Heath Extension Chain Catchment

**Camden Geological, Hydrogeological
and Hydrological Study**

Hampstead Heath Surface Water
Catchments and Drainage

213923

FIGURE **14**

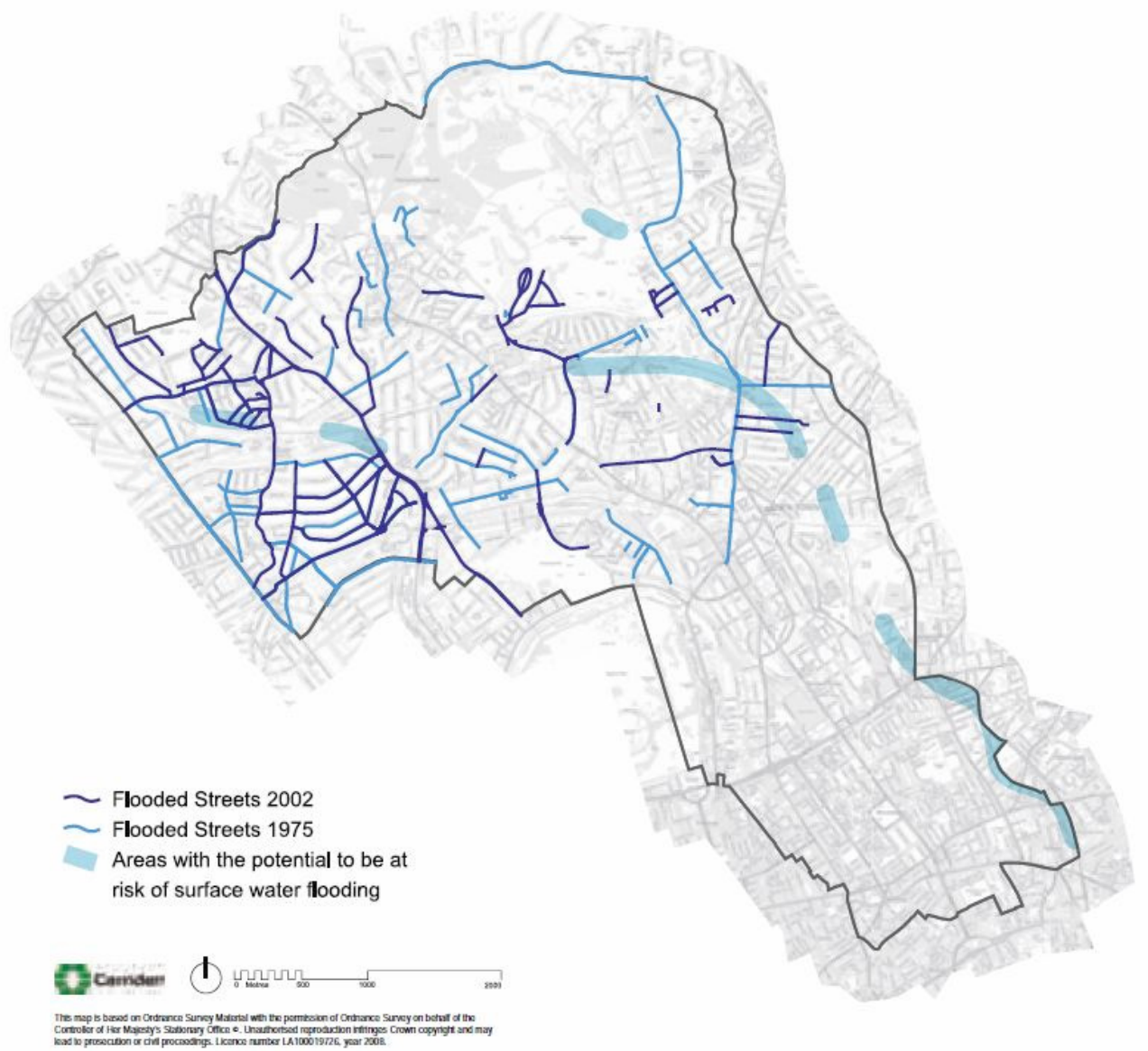
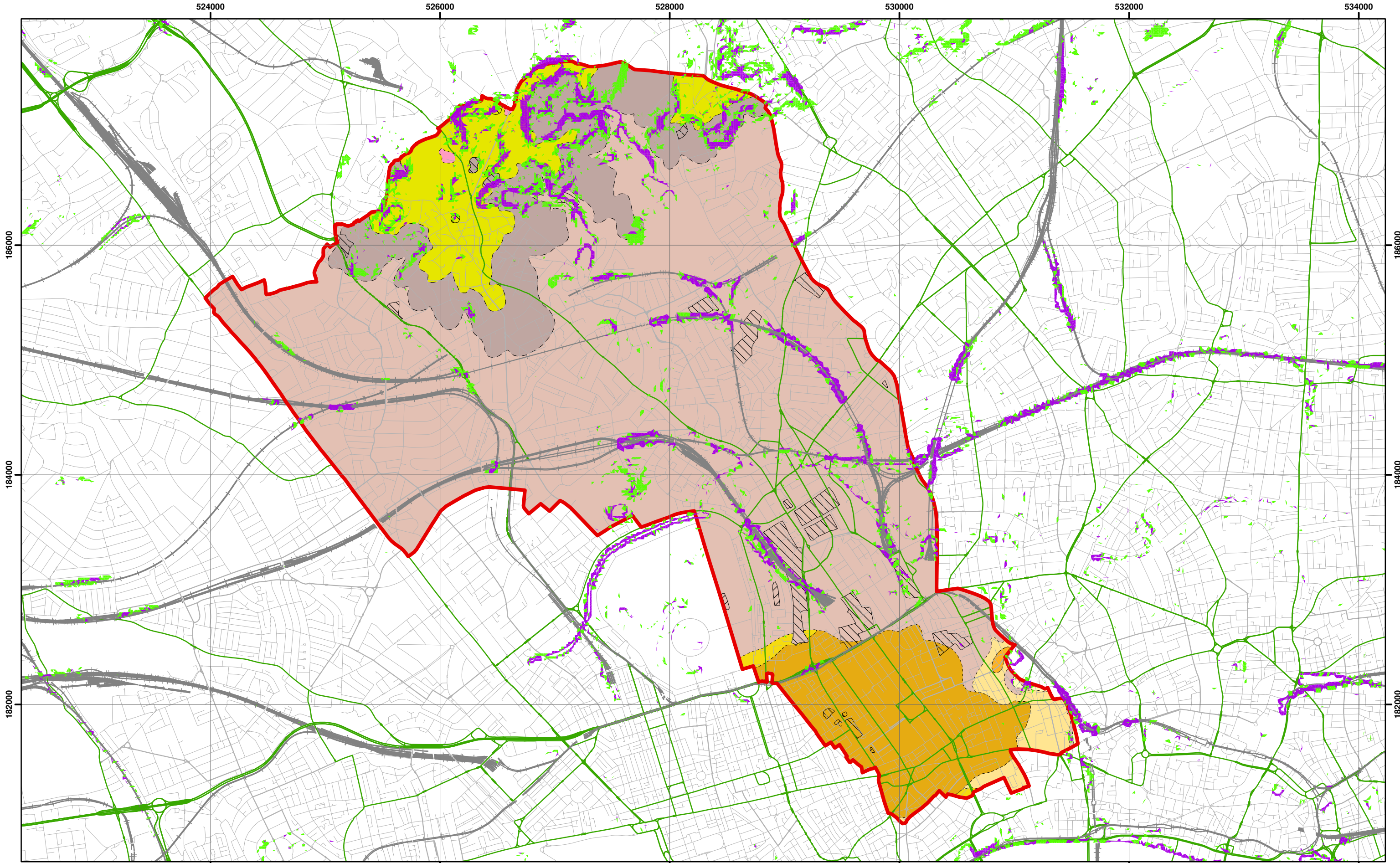

Figure 5 from Core Strategy, London Borough of Camden

**Camden Geological, Hydrogeological
 and Hydrological Study
 Flood Map**



Slope Angles calculated from Digital Terrain Model Provided By Camden Borough Council

Scale at A3: 1:30,000

0 0.5 1 2 3
Kilometers

1:10,000 BGS Mapping
Coordinate System:
British National Grid
GCS_OSGB_1936

Legend

- | | | | | |
|--------------|--------------------------|-----------------------------|-----------------------------|-------------------------|
| Slope | London Borough of Camden | BGS 1:10K Artificial Ground | BGS 1:10K Drift Geology | BGS 1:10K Solid Geology |
| 0° - 7° | Railway Lines | MADE GROUND | ALLUVIUM | BAGSHOT FORMATION |
| 7° - 10° | A Roads | WORKED GROUND | HACKNEY GRAVEL FORMATION | CLAYGATE MEMBER |
| > 10° | | | LANGLEY SILT FORMATION | LAMBETH GROUP |
| | | | LYNCH HILL GRAVEL FORMATION | LONDON CLAY FORMATION |
| | | | STANMORE GRAVEL FORMATION | |

NB. Geological boundaries are largely indicative based on available geological mapping data

**Camden Geological, Hydrogeological
and Hydrological Study**
Slope Angle Map

213923

FIGURE

16

Areas of greatest potential for slope instability

The assessment of the potential for slope instability

Due to a long history of intensive landuse and urban development it has only been possible to recognise and map, with confidence, a few areas of past landslide activity. However, beyond the north London district, areas of similar bedrock geology and topography contain significant areas of mapped landslides. Therefore, a slope instability assessment has been made to act as a guide to where areas of significant landslide potential are present, but obscured, and where further information regarding their stability are needed before development or major changes in landuse are made (Forster et al. 2003).

The assessment used a deterministic approach that looks at the presence at a site of landslide causative factors, such as slope angle, lithology and groundwater conditions that increase the susceptibility of a site to landslide activity. The causative factors were weighted according to their relative importance in promoting landslides and combined in a Geographical Information System to produce a computer-generated map of the relative susceptibility to landslide activity across the area. It does not necessarily mean that landslides have happened in the past or will do so in the future but if conditions change through natural or artificial means and a causative factor increases, then slope instability may be triggered.

This assessment gave a measure of the potential landslide activity divided into five classes ranging from zero to very high. For clarity the two highest classes, HIGH and VERY HIGH have been combined on this map to give a single rating to indicate the presence of a significant potential. More detailed information about particular locations may be obtained through the BGS Enquiry Service enquiries@bgs.ac.uk. Telephone 0115 936 3143.

The shaded relief image is derived from NEXTMap™ Digital Elevation Model (DEM) data gridded at 10 m intervals. Illumination is from the north-west and vertical exaggeration is x10. Artificial artefacts such as buildings have been removed from this dataset using smoothing algorithms. The geology of the district can be related to the topography as revealed by the image. The hill tops capped by the Claygate Member and Bagshot Formation are clearly identifiable. The watersheds dividing the Thames, Lea and Colne river valleys are visible, as are the large reservoirs on the floor of the Lea valley.

FORSTER A, WILDMAN G AND POULTON C. 2003. Landslide potential modelling of North London. British Geological Survey Internal Report, IR/03/122R.

Areas of significant landslide potential

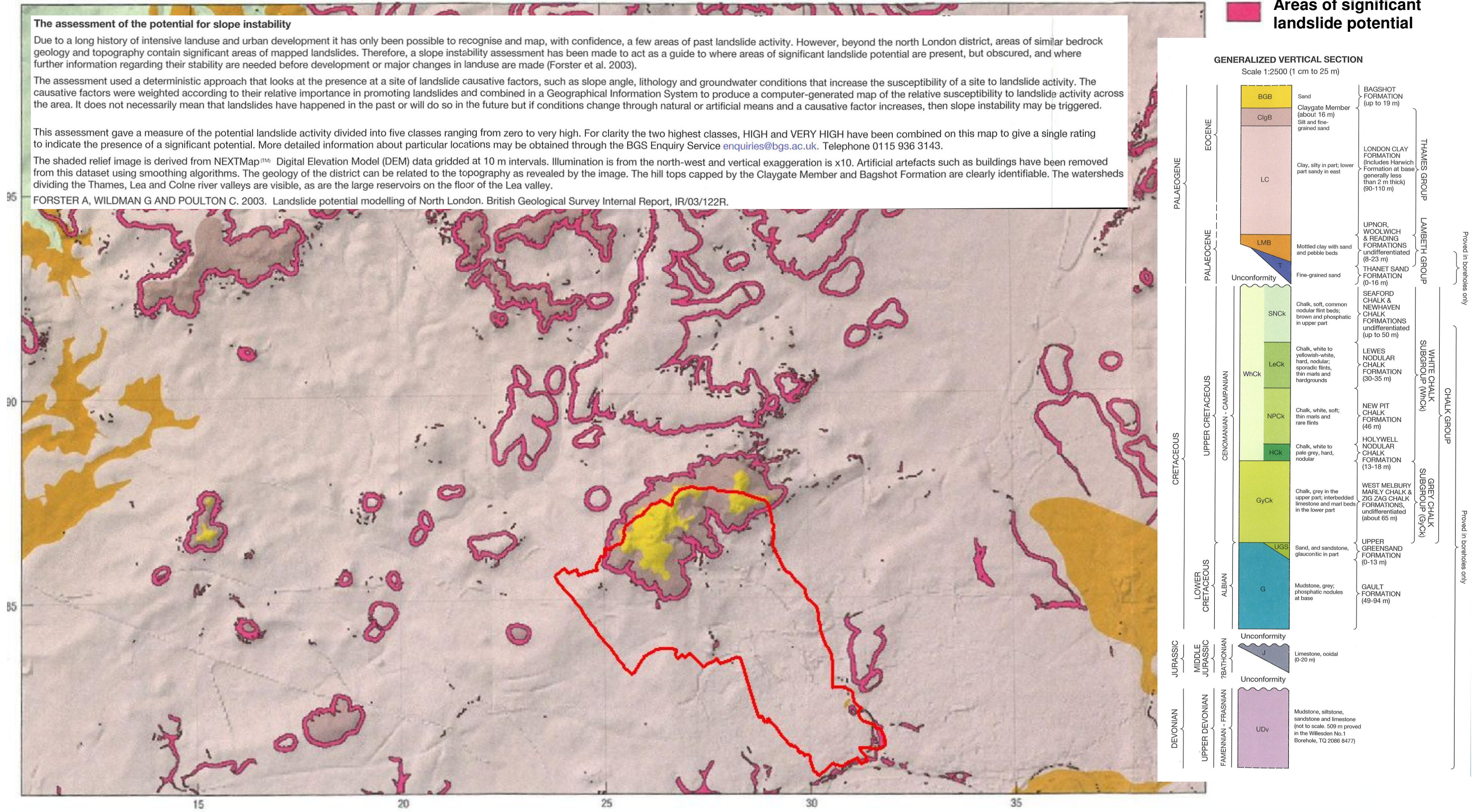

Source - British Geological Society, 1:50,000 Series England and Wales Sheet 256 – North London

Camden Geological, Hydrogeological and Hydrological Study
Areas of landslide potential

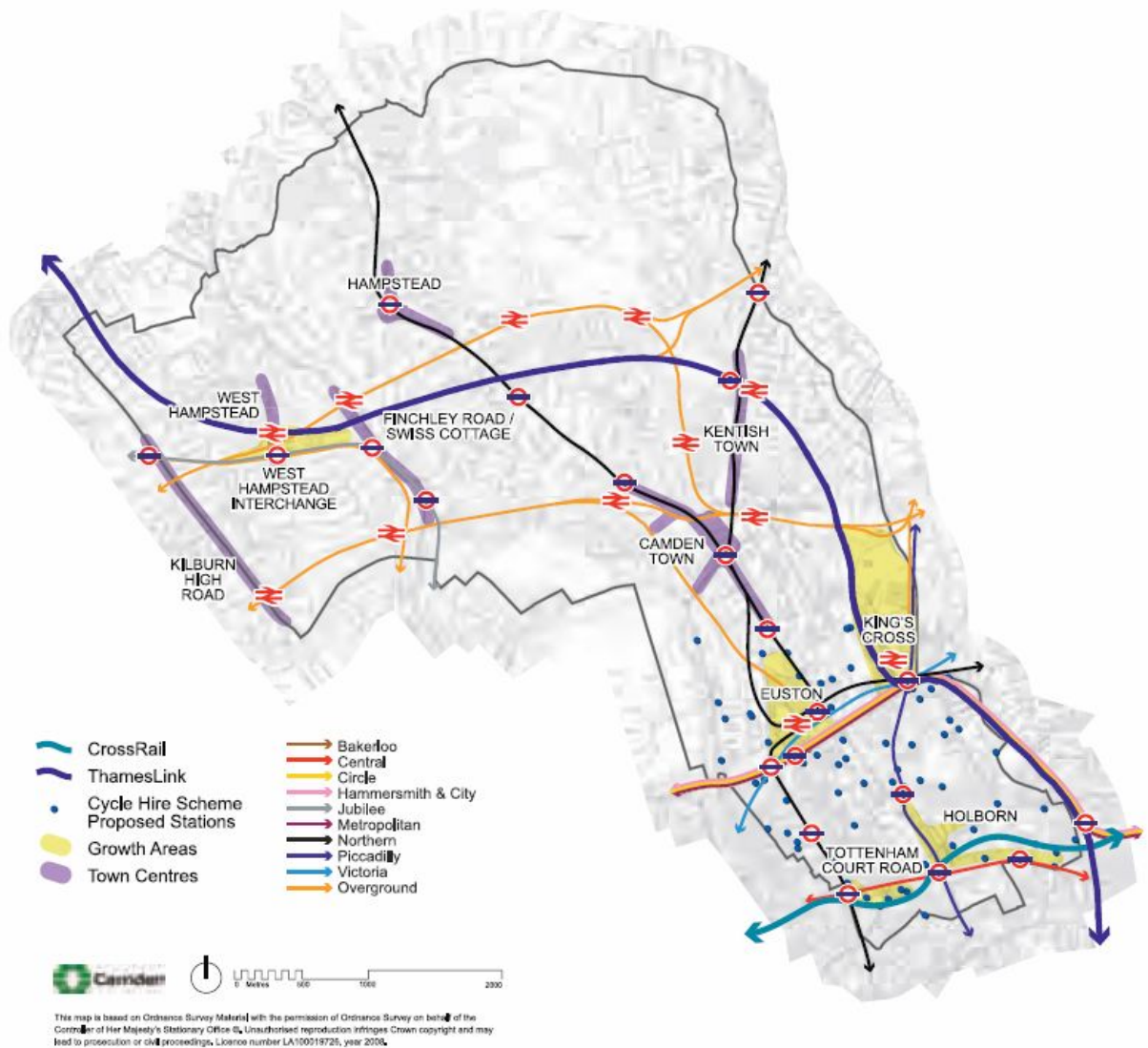

Source - London Borough of Camden, January 2010. *Camden Core Strategy Proposed Submission*.

Camden Geological, Hydrogeological and Hydrological Study Transport Infrastructure

Stage 0: original foundation, typical of houses

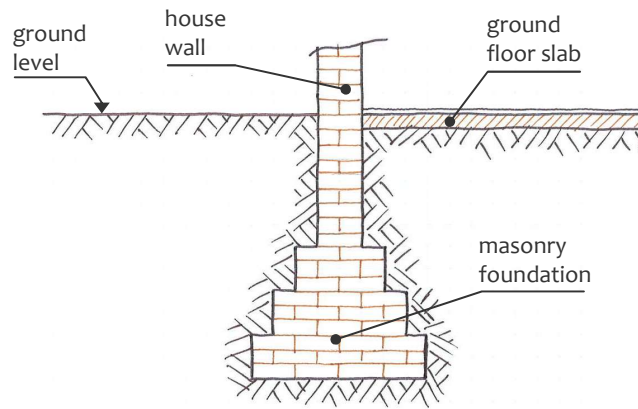

Stage 1: exposure of original foundation by digging a short trench along a section of the wall to be underpinned

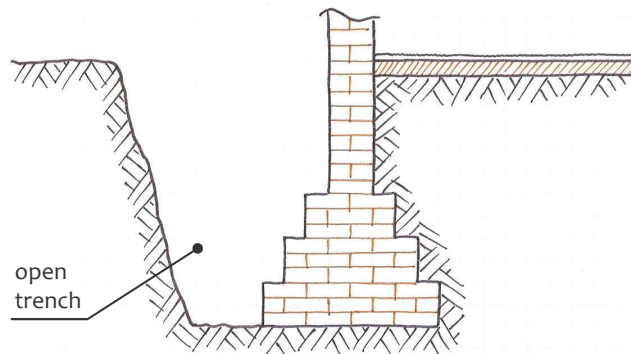

Stage 2: excavation of pit to form underpin: see Fig. 2.1b for details

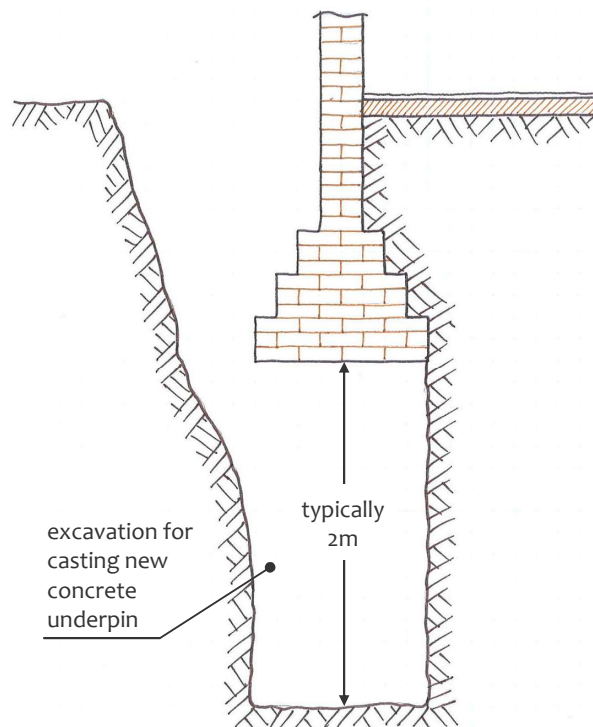

Indicative, schematic sketches only.
Actual dimensions are likely to vary.
Not to scale.

Camden Geological, Hydrogeological and Hydrological Study

Typical underpinning construction sequence

Stage 2a: excavation and concreting of initial section

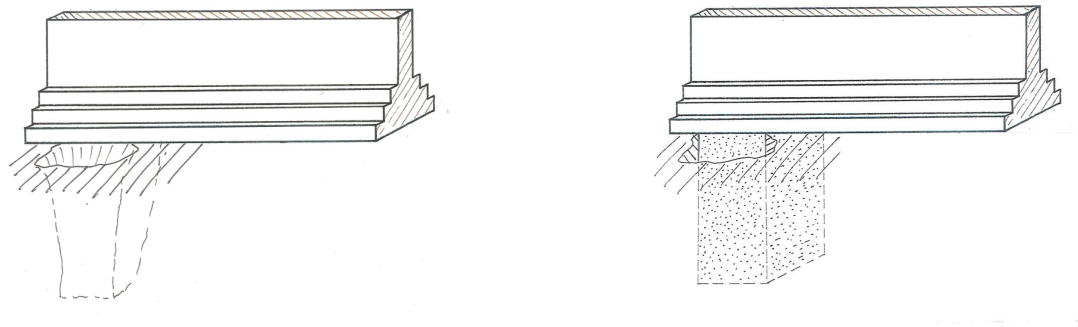

Stage 2b: excavation and concreting of another section, not adjacent to first one

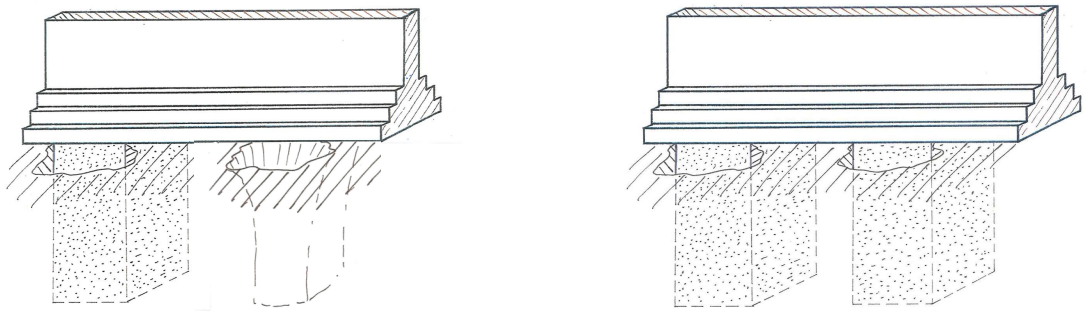

Stage 2c: excavation and concreting of an intermediate section, to form contiguous rows of underpin

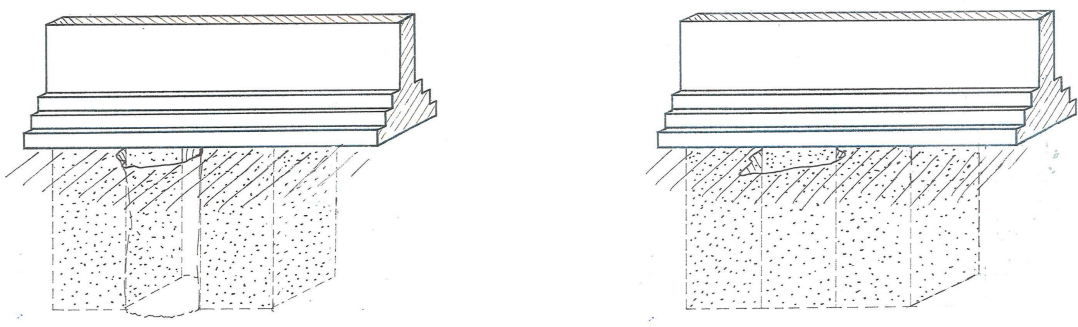

Indicative, schematic sketches only.
Actual dimensions are likely to vary.
Not to scale.

**Camden Geological, Hydrogeological
and Hydrological Study**
Underpinning construction sequence with
'hit and miss' pattern